

# Nardò Technical Center

Porsche Engineering

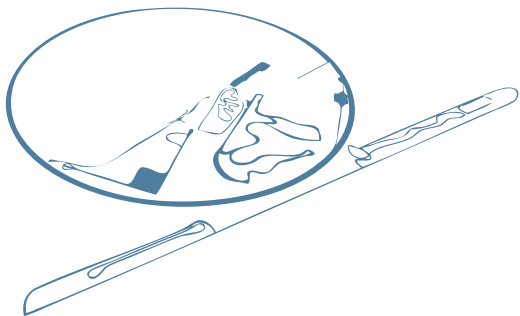

## Safety Handbook



# Index

1. Introduction

---

2. General Information

---

3. General Conditions and Definitions

---

4. Legal Regulations

---

5. General Regulations

---

6. Operating Instructions

---

7. Tracks & Facilities

---

8. General Facilities and Services

---

1

2

3

4

5

6

7

8

# 1. Introduction

The purpose of this document is to present to all Customers, suppliers and employees the provisions and regulations regarding environmental protection and health and safety of resources operating at Nardò Technical Center (hereafter NTC) and the procedures in place at the Proving Ground in order to make access to services easier. We would kindly ask you to carefully read all the information given in this handbook. To ensure maximum safety of all users at the Proving Ground, it is of utmost importance to respect and comply with the safety and security rules.

Non-compliance with the regulations may endanger yourself and others. Copies of this NTC Safety Handbook are available at each of the Proving Ground's workshops. For any information on safety regulations, please contact Customer Care. Copies of this guide are available for reference in all the workshops and can be downloaded online by scanning the QR code.



### **Help us to maintain the highest possible standards**

NTC is committed to ensure the highest standards in terms of environmental protection and worker health and safety. Company policies are defined and implemented in compliance with international certifications UNI EN ISO 14001:2015 for the Environmental Management System, UNI EN ISO 45001:2018 for the Health and Safety Management System and TISAX for Trusted Information Security Assessment Exchange for the automotive industry.

To help us achieve and maintain service excellence, we welcome your comments concerning this handbook and our safety and security regulations at: [customercare@porsche-nardo.com](mailto:customercare@porsche-nardo.com)

## 2. General Information

### 2.1 Contacts

#### Emergency Number

Tel.: +39 0833/877 **470**

Cel.: +39 335/1200964

#### Customer Care

Tel.: +39 0833/877 **404**

+39 0833/877 **526**

#### Track Management

Tel.: +39 0833/877 **448**

+39 0833/877 **458**

#### Medical Services

Tel.: +39 0833/877 **449**

Cell.: +39 342/8986913

#### Security

Tel.: +39 0833/877 **438**

+39 0833/877 **111**

Cell.: +39 342/3989778

### 2.2 Languages spoken

German, English, Italian

## 2.3 Working Times

Tracks in ordinary use are available 24 hours a day.

Tracks in exclusive use are only available on request.

## 2.4 Check in/out

On arriving at the gate you will need to identify yourself to the security personnel. If you are on the list of expected arrivals, you will be given an entry badge which you will have to present every time you leave or return. The authorised vehicles indicated in the booking document will be provided with a label valid for departure/re-entry. Lorries should be parked in the dedicated maneuvering area outside the Proving Ground. Afterwards, drivers will be able to check in themselves at the Security Reception to enter. Drivers need to check in first and will then be asked to proceed to the entrance.

The NTC Security Reception will supply the keys to the workshops booked by the Customer. Your name, surname, ID number and a digital photo should be communicated in advance, together with the booking document. This will significantly accelerate the entry procedure at the gate.

## 2.5 Vehicle Equipment

At the Track Management Office, you must collect your test equipment with the ticket indicating the assigned project number, provided by the Security personnel, and provide a description and schedule of the activities that will be carried out on each facility. At the same office, you must collect:

- TAG for each vehicle
- fuel card
- VTS (Vehicle Tracking System) for security and service communications (intercom systems required)
- flashing lights for specific tests
- "Welcome Folder" containing a summary of planned activities and test equipment received, Tracks' Activity Information, useful numbers, general information, and the Customer Satisfaction Survey.

All vehicles must be equipped with the aforementioned items. It is also mandatory to carry a safety vest and towing hook. All equipment must be returned to the Track Management Office upon completion of the testing activity.





## 2.6 Video Monitoring on Test Tracks

Cameras are installed on the following tracks to monitor test activity:

- High Speed Ring
- Low Speed Ring
- Handling Track
- Dynamic Platform A
- Dynamic Platform B
- Noise Track
- Low Friction Area
- Tracks entrances

Tracks are exclusively monitored for safety reasons.

The images are transmitted to control rooms in the Track Management Office and Fire Station, and are only reviewed by authorised Nardò Technical Center personnel.

## 2.7 Emergencies

In case of emergencies of any kind, please call the

**Emergency Number:  
+39 0833/877 470**

Depending on the kind of emergency, communicate:

- **'Fire'** in case of fire
- **'First Aid'** in case of health-related emergencies

If you are calling from an internal landline, i. e. from inside the workshops, you can dial extension **470** and the emergency team will be able to directly locate your position. If you call from a mobile phone, you will also need to communicate your position. NTC has its own fire brigade, industrial safety and first aid team that is available 24/7 to intervene immediately in emergency situations on the whole Proving Ground area. Please note that in case of emergencies, a red signal light will flash above the Track Management Office door. Access to the office is not authorised in this case.

### 2.7.1 Assembly Points

In case of situations in which workshops or office buildings have to be evacuated, there are three assembly points situated as indicated on the map on the right. Please refer to the evaluation maps present in all facilities

to determine which assembly is allocated to your current location. In case of an evacuation situation please proceed to the closest assembly and wait for instructions from the NTC Emergency Staff.

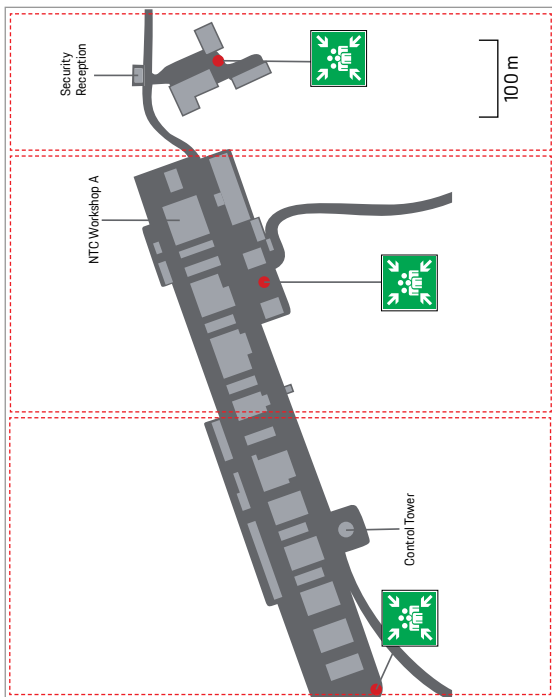

## 2.8 Electric/Hybrid Vehicles

Within the Proving Ground, all electric and hybrid vehicles must be easily identifiable. To this end, Customer must provide through NTC Sales/Customer Care, the Rescue Data Sheet. Emergency personnel, through inspection, will verify with the Customer the safety and rescue related features of the car. Stickers such as: hazard pictogram on all sides of the car and RDS-related numbering on the front and back of the car will be placed on all electric and hybrid cars.

**Electrocution hazard warning**  
Applied on all sides of the car

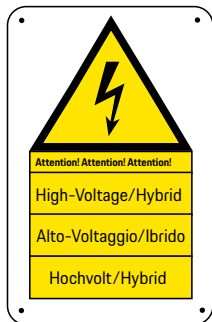

**Red numbering for electric cars**  
Applied to front and back of car

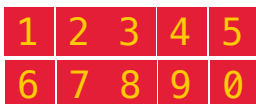

**Yellow numbering for hybrid cars**  
Applied to front and back of car



## 3. General Conditions and Definitions

### 3.1 Confidentiality and Safety

At the Security Reception:

- it is compulsory to declare and deposit the following equipment (which can be collected on the way out):  
cameras, video cameras and any other imaging devices
- it is compulsory to hand over cell phones with built-in camera so that it is obscured with adhesive labels that cannot be removed while in the NTC premises
- it is compulsory for laptops to be authorized by the staff who will register serial numbers and obscure any webcams.

If you want to take pictures or videos, you must submit a specific request to the NTC Security Reception.

Video/photographic services are agreed and monitored by Security staff to ensure confidentiality.



### 3.2 Customer Responsibilities

When coming to the NTC, your company has full responsibility for all drivers, other personnel, suppliers and guests. Therefore your company, with its team leaders, must inform all personnel involved in the NTC activity about these rules and regulations, and make sure they comply with them.

Requirements:

- valid driving licenses (according to the vehicle class)
- qualifications for the tests/jobs to be performed
- good health and proper insurance
- valid NTC Proving Ground Usage License

If you do not fulfil all of the requirements mentioned above, you are obliged to report this immediately to the NTC Security Reception at the entrance gate. You and your company are responsible for all of your vehicles entering the Proving Ground. These have to be in good condition and properly insured for the planned tests.

The Customer's on-site team leader must ensure at all times that vehicle camouflage is well attached and does not endanger other Customers. Your company bears full responsibility for any consequences as a result of your camouflage.

You are obliged to provide the NTC with a Rescue Data Sheet for every test vehicle. The NTC is insured against any damage for which it is responsible.

## 4. Legal Regulations

### 4.1 Italian Public Roads Code

The Italian Public Roads Code is in force on all service roads and NTC areas. Please observe the speed limits provided by the signs on all service roads as well as the limits provided on the various test tracks as per internal regulations and procedures. Always pay attention to pedestrians especially around the workshops, offices, and refreshment areas.

### 4.2 Italian Legislative Decree 81/08

Legislative Decree 81/08 and subsequent supplementary amendments (see the Italian Parliament website for detailed information) is in force for regulations on the protection of health and safety in the workplace for its own employees.

### 4.3 Italian Legislative Decree 152/06

For regulations on environmental protection and waste management, Legislative Decree 152/06 and subsequent supplementary amendments apply (see the Italian Parliament website for detailed information).

## 5. General Regulations

### 5.1 Safety in driving

#### Overall regulations:

- fasten your seatbelt
- don't drive or work if you are under the influence of alcohol or drugs (limit: 0%)
- do not introduce and consume alcohol or drugs within NTC premises
- don't drive if you are tired or sleepy
- don't smoke in your vehicle (including e-cigarettes)
- don't work on the computer while driving
- equip your vehicles with high visibility safety vests (one for each passenger) that have to be worn whenever you exit the vehicle on a road or track
- don't use mobile phones while driving
- properly secure sand bags and other testing equipment in your vehicle
- Observe the speed limits indicated by the signange and do not conduct testing activities outside of the test tracks.
- In the common areas, observe the speed limit of 30 km/h and do not conduct testing activities.

Diet is very important during working hours, particularly for safety reasons:

- follow a well-balanced diet
- drink plenty of water every day especially in hot weather



### **Before accessing a test track, you must:**

- check the general condition and correct operation of your vehicle
- check that your VTS works well
- check tires condition
- check that your VTS battery is charged
- put the Track Access Gateway (TAG) device in the correct position (see Section 6.4)
- make sure that you have a tow-bar on board
- make sure that you have the emergency message sticker on board

### **On the track:**

#### **a) you must:**

- switch on your vehicle lights (low beam)
- stick to the agreed test schedule and only use equipment authorised by Track Management
- pay attention to the traffic situation
- report hazardous situations (e. g. accidents on the track, oil slicks, fog, etc.), incorrect behaviour and near-miss situations by VTS to Track Management

#### **b) it is strictly prohibited to:**

- stop or make U-turns in the test lanes (stopping is exclusively permitted in emergency situations in SOS lay-bys or emergency areas)
- cross or walk

- pull up next to a broken down vehicle
- throw objects from windows
- leave objects behind
- tow away a vehicle by your own team

**c) if your vehicle breaks down, you have to:**

- activate the vehicle hazard lights
- stop in the nearest (SOS) lay-by or emergency area
- report your position to Track Management, which will manage the emergency situation
- place yourself in a safe condition, making yourselves visible to emergency vehicles, close to your vehicle (away from run-off areas and trajectories), wearing your safety vest

### **Recommendations**

Wear a helmet in vehicles without airbags or with deactivated airbags or in vehicles equipped with roll-bars. Equip vehicles with fire extinguishers, glass breaking hammers, and seat belt cutters and secure them to the vehicle.

Adverse weather conditions or natural events may cause hazardous limitations to driving visibility or water planning phenomena. Under these conditions, users are required to adopt the most common and cautious rules of conduct already established by the traffic laws. NTC will broadcast an alert via VTS and display a visual alert where available.

When using the tracks, we recommend that you drive the first lap at a low speed to familiarize with the track and verify the general conditions of the system.

### **Violations**

In case of violations of these conditions, NTC reserves the right to intervene in the manner and form prescribed by law, its internal safety regulations and/or inhibit access to the Proving Ground and test tracks to the offending person.

### **Specific Regulations for Motorcycle Riders**

You are only allowed to drive a motorcycle if you are wearing complete protective equipment, helmet and intercom system, protective suit and all PPE required by the activity to be performed.

The face visor must be kept permanently closed.  
Keep the VTS in sight and accessible at all times.

1

2

3

4

5

## 5.2 Flag Signals on the Tracks

Flags are used on all tracks, indicating the following rules:



**STOP** immediately in an emergency lane or SOS lay-by.



**CAUTION**, no overtaking.



Track is free now.



Track closed, finish your lap and exit.

1

2

3

4

5

## 6. Operating Instructions

### 6.1 Vehicle Tracking System (VTS)

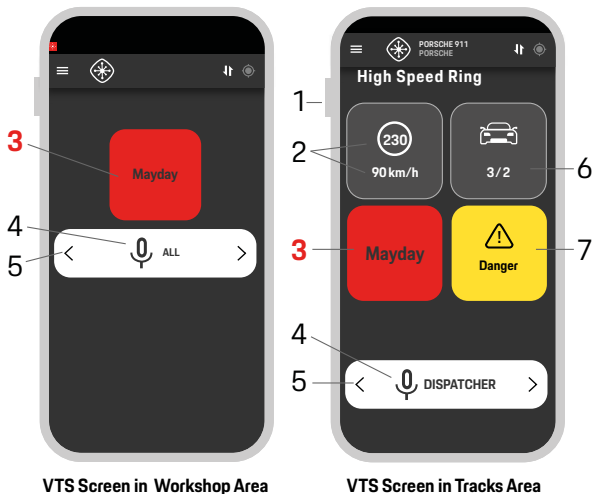

VTS Screen in Workshop Area

VTS Screen in Tracks Area

#### Radio Usage

1. Push-to-talk button
2. Speed limit indicator on track and driving speed
- 3. MayDay button**
4. Button for sending a voice communication
5. Buttons to scroll through the enabled groups for sending and listening to a voice communication
6. Number of vehicles on the track/ number of vehicles permitted on the track (if provided by the track)
- 7. Danger alarm send button**

## VTS operating instructions

- The communication group can be selected from the side button push-to-talk (1), alternatively you can scroll through the enabled groups at the bottom of the screen (5)
- To communicate with the selected group, press and hold the Push-to-talk (1) side button on the phone or press and hold the button with the microphone icon (4) and speak when the microphone area turns green
- Select the „Dispatcher“ group to use the Dispatcher group for service communications
- Likewise, when the device receives a communication, the button with the microphone icon changes colour
- To communicate a **MayDay (3)** or a **Danger (7)** to the Control-Room, it is necessary to press and hold the respective button for 2 seconds and then communicate the problem with push-to-talk (1)
- The **MayDay (3)** or a **Danger (7)** communication is received on the Dispatcher channel, the button with the microphone icon (4) starts flashing until the emergency is resolved
- When the speed limit allowed by the track is exceeded the dedicated icon (2) starts flashing

1

2

3

4

5

6

## 6.2 VTS Messages

There are different messages, each to be communicated in different situations. The following tables show the four message types. All users of the Proving Ground need to be able to understand all messages and know the appropriate reaction when hearing them.

All messages need to be transmitted in English to ensure they are understood by all users.

### Emergency Message

① Warning	② Where?	③ What happened?
Mayday, Mayday, Mayday, Stop Activity Stop Activity	<ul style="list-style-type: none"><li>▪ High Speed Ring</li><li>▪ Dynamic Platform A</li><li>▪ Workshop B1</li><li>▪ ...</li></ul>	<ul style="list-style-type: none"><li>▪ Accident</li><li>▪ Fire</li><li>▪ First Aid</li></ul>

If you hear this message:

**stop immediately on all tracks** (in security areas).

### Danger Message

① Warning	② Where?	③ What happened?
Danger, Stop Activity on...	<ul style="list-style-type: none"><li>▪ Handling Track</li><li>▪ High Speed Ring</li><li>▪ Dynamic Platform A</li><li>▪ ...</li></ul>	<ul style="list-style-type: none"><li>▪ Debris removal</li><li>▪ Animal presence</li></ul>



If you hear this message from another user:  
**stop immediately** on the **affected track** (in security areas).

### Caution Message

① Warning	② Where?	③ What happened?
<b>Caution</b>	<ul style="list-style-type: none"><li>▪ Handling Track</li><li>▪ High Speed Ring</li><li>▪ Dynamic Platform A</li><li>▪ ...</li></ul>	<ul style="list-style-type: none"><li>▪ Vehicle Recovery</li><li>▪ Low Visibility</li><li>▪ Heavy Rain</li></ul>

If you hear this message from another user:  
**Take care** and **slow down** on the **affected track**.

### Attention Message

① Warning	② Where?	③ What happened?
<b>Attention</b>	<ul style="list-style-type: none"><li>▪ Handling Track</li><li>▪ High Speed Ring</li><li>▪ Dynamic Platform A</li><li>▪ ...</li></ul>	<ul style="list-style-type: none"><li>▪ Resuming Activity</li><li>▪ Exclusive use from ... To ...</li></ul>

If you hear this message from another user:  
**pay attention** to the information provided.

## 6.3 Signal Lights

### Traffic Lights

The track access routes have two red/green traffic lights, located as indicated on the map below. If the lights are red, it is prohibited to proceed beyond them. Both test tracks and access routes are closed in this case.

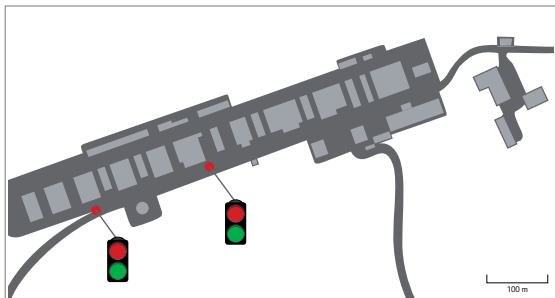

Traffic Lights Location

### Signal Lights on NTC Vehicles

#### Yellow warning lights

Yellow warning lights are used to **attract attention** to maintenance and/or vehicle recovery operations by the following service vehicles:

- maintenance vehicles
- tow trucks
- Safety Car

If any of these vehicles are flashing their yellow warning lights, please **pay attention** to the traffic and to VTS communications.

### **Blue warning lights**

Blue warning lights are used in emergency situations by the following service vehicles:

- rescue vehicles
- Safety Car

If any of these vehicles are flashing their blue warning lights, please reduce your speed, pay attention to VTS communications and **stop your vehicle** if necessary.

#### **6.3.1 Safety Car**

The NTC Safety Car monitors the tracks and facilities in order to ensure compliance with the rules of the Proving Ground ('Do The Right Thing!'). The Safety Car can display diverse messages. It is mandatory to respect and follow the indications given on the display.

1

2

3

4

5

6

## 6.4 TAG (Track Access Gateway)

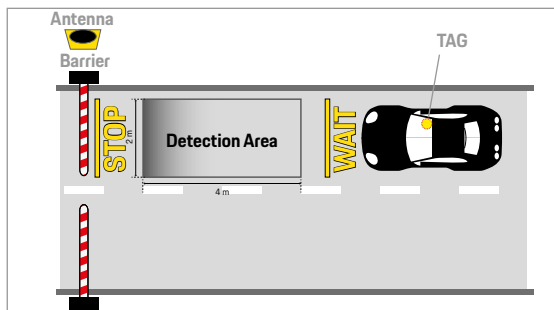

TAG System

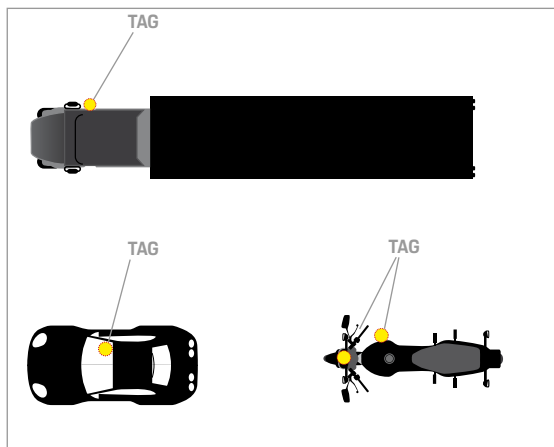

Position of TAG on vehicles

To open the barriers and access the test tracks, it is required to:

1. wait until the barrier is completely closed (in case of a vehicle in front) before entering
2. approach slowly
3. stop next to the tag reader located near the barrier itself, observing the road markings.

The opening of the barrier will take a few seconds. The TAG must be placed inside the passenger compartment on the windscreen of the vehicle.

### **6.5 Petrol Station and Fuel Card**

Nardò Technical Center has its own petrol station with:

- 95 RON
- 98 RON
- 100 RON
- DIESEL
- BIODIESEL
- SPECIAL DIESEL
- E10
- AD BLUE

Fuel cards for the different types of fuel are available from the Track Management Office. The number of litres will be recorded on your fuel card. Special fuels have to be bought separately in advance.

Refueling of service vehicles is not allowed inside the Proving Ground.

## Safety Information

- Smoking is strictly prohibited in and around the petrol station
- U-turns are not allowed
- If fuel is spilled, please inform Track Management immediately
- Filling up spare tanks is prohibited
- Touch any metallic part to release any possible electromagnetic charge before filling up
- It is strictly prohibited to fill up with your engine running
- It is prohibited to use cell phones during refueling operations

## 6.6 Electric/Hybrid Vehicle Charging Station

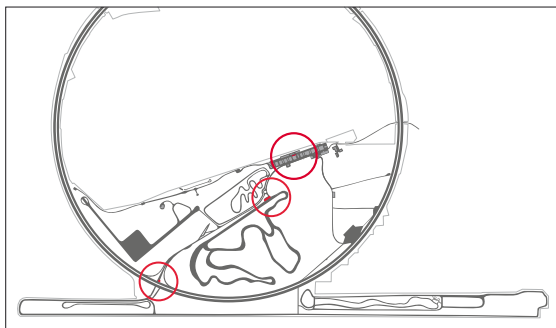

The following charging stations are available within Nardò Technical Center:

- PE HPC Charging Stations 350kW
- EFAPOWER EV HV350 ULTRAFast
- EFACEC QC45 50 kW 400 VDC
- ABB Terra HP cp500 350kW
- ABB Terra 54HV 50kW
- ABB Terra 54CJG 50kW
- ABB UFCS 175kW
- Hypercharger Alpitronic 75kW
- Wall boxes 22 kW
- Charging points from 16 A to 63 A

In addition, are available:

- Wall boxes 22 kW
- Charging points from 16 A to 63 A

Recharging of service vehicles is not allowed inside the Proving Ground.

### Safety information

Porsche Engineering's HPC charging stations are equipped with visual barriers and thermal cameras directly connected with the Firefighters Station. Near all electric charging facilities there are emergency boxes equipped with fire extinguishers. Please contact Track Management in order to use the charging stations. You are only permitted to charge electric/hybrid vehicles in these specific areas, as shown in the map.

## 6.7 Car Wash Stations

### a) Automatic Car Wash (tunnel)

Vehicles up to the following dimensions can be washed here:

Description	Dimension (mm)
Maximum vehicle length	5.000
Maximum vehicle height	2.225
Maximum vehicle width	2.100

### b) Manual Car Wash (high pressure spray)

There is a high pressure spray nozzle for washing cars by hand near the automatic car wash. A different one for commercial/industrial vehicles is available on demand.



### c) Vacuum Cleaner

A vacuum cleaner is available at the automatic car wash.

#### Safety Information

- Do not stay in the vehicles during the wash
- The operating range of the wash system should not be entered during the wash without attendance of the operator and only with his agreement
- No persons are allowed within the operating range of the wash system during the wash. The driving range must be kept clear

#### Prior to the wash:

- Remove aerials or push them in. For vehicles with automatic aerials: switch off the radio.
- Fold in the mirrors if necessary and remove any extra mirrors
- Check that additional lights or headlights are securely attached.
- Switch windshield wipers to their home position
- Remove all loose parts, such as extra parts attached to windshield wipers or similar objects
- Close the sunroof. For convertibles: close the top.
- Lock the vehicles (doors, trunk, tailgate, fuel filler cap)

## 7. Tracks & Facilities

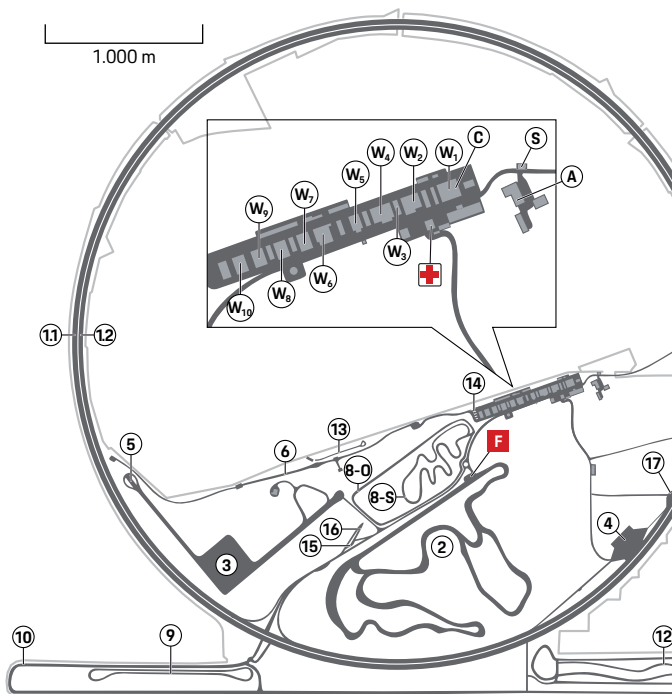



Map of the Proving Ground

- 1.1 High Speed Ring
- 1.2 Low Speed Ring
- 2 Handling Track
- 3 Dynamic Platform A
- 4 Dynamic Platform B
- 5 Low Friction Area
- 6 Noise Track
- 7 Special Pavements Track
- 8-O Strada Bianca «O»
- 8-S Strada Bianca «S»
- 9 Dust & Gravel Oval
- 10 Africa Road A-B-C
- 11 Tire Laceration Road
- 12 Cross-Country Road
- 13 Mud Road
- 14 Concrete Slopes
- 15 Rolling Track
- 16 Reverse Gear Track
- 17 Assisted Parking Test Area
- S Security Reception
- C Customer Care/Track Management
- A Administration
- ⊕ First Aid
- F** Fire Station
- W<sub>1</sub> Workshop 1
- W<sub>2</sub> Workshop 2
- W<sub>3</sub> Workshop 3
- W<sub>4</sub> Workshop 4
- W<sub>5</sub> Workshop 5
- W<sub>6</sub> Workshop 6
- W<sub>7</sub> Workshop 7
- W<sub>8</sub> Workshop 8
- W<sub>9</sub> Workshop 9
- W<sub>10</sub> Workshop 10

1

2

3

4

5

6

7

## 7.1 Track 1: Ring Tracks

There are 8 signal panels on the Ring Tracks, indicating the following rules:



**STOP**, dangerous driving conditions. Stop immediately in the emergency lane, wait for instructions from Track Management.



**CAUTION**, difficult driving conditions. Slow down.



**ATTENTION**, hard braking test in progress. Watch out for cars with blue and yellow flashing lights.

In case of an emergency, the red light can be switched on by pushing the red button on the control pad located on each signal panel.

The signal panels are announced by:



Next signal panel in 300 m distance.

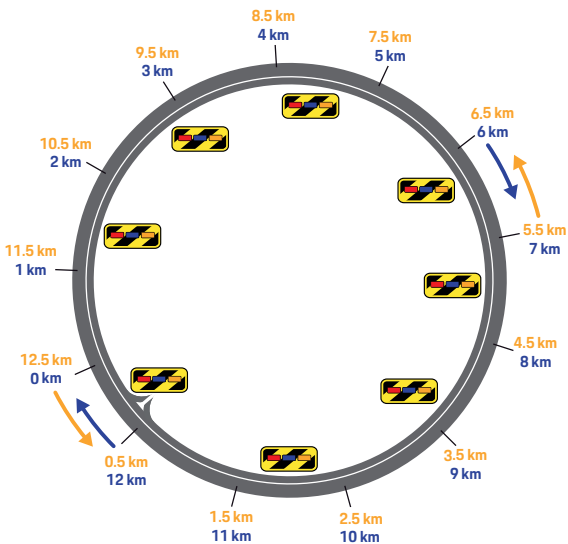

Signal Panels on Ring Tracks

1

2

3

4

5

6

7

## 7.1.1 High Speed Ring

High Speed Ring			
Lane	Length (m)	Compensated speed (km/h)	Allowed speed range (km/h)
0	12.680,1	245	220 – 260
I	12.655,0	195	180 – 220
II	12.629,8	158	130 – 180
III	12.604,7	101	60 – 130

This test track has four lanes with different bankings and speeds in a perfect circle with a diameter of 4 km. It can be used by cars and motorcycles.

### Track-specific Rules

- The speed limit is 260 km/h. It can only be exceeded during exclusive use
- All vehicles must leave the track 10 minutes before the start of exclusive use, which is communicated 30 minutes beforehand
- You must use the appropriate lane, according to the vehicle speed. When entering and leaving, cautiously make your way to and from this lane
- Overtaking must always be performed in the outer lane
- If you change lanes (e. g. deceleration test, overtaking), you must respect the appropriate speeds for each lane and indicate appropriately

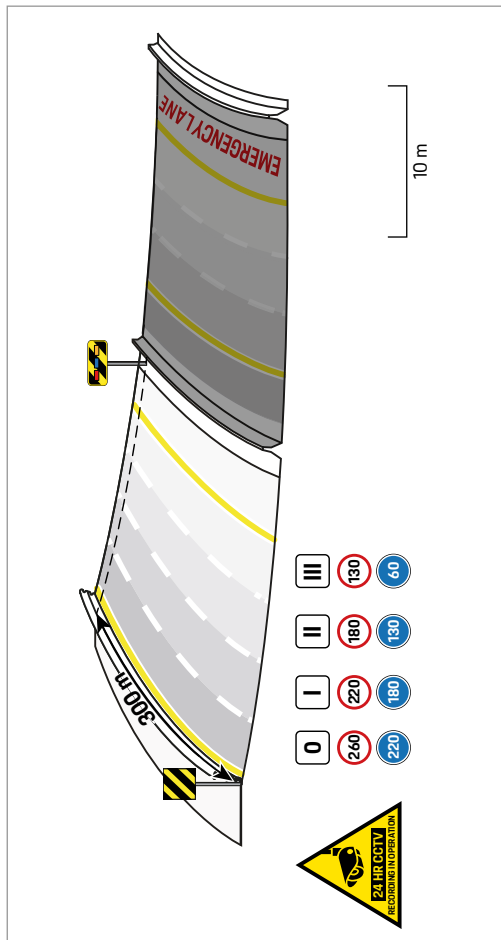

## High Speed Ring

1

2

3

4

5

6

7

- Before performing a braking/deceleration test, please note the mandatory use of flashing lights (see description on the following pages)
- Constant speeds below 60 km/h are not allowed

### **Safety Information**

In case of an emergency:

- switch on your hazard lights and stop in the emergency lane
- communicate the situation to Track Management by NTC VTS

In case of an accident, use the NTC Accident Emergency Message (see Section 6.2).

Emergency boxes are mounted on the concrete wall at 250 m intervals.

### **Braking/Deceleration Tests**

General regulations:

- Customers' team leaders wishing to perform this type of test take full responsibility for the execution of such manoeuvres
- vehicles must be equipped with the appropriate flashing lights
- the functionality of the vehicle's flashing lights needs to be checked before accessing the track



- drivers must notify Track Management via NTC VTS of the start and end of each braking test session specifying Hard Braking in the message and using the Dispatcher group
- overtaking slower cars on an inside lane is strictly prohibited
- carefully observe the traffic before starting
- speeds below 60 km/h are only allowed during braking/deceleration tests activating the emergency lights
- hazard lights must only be used:
  - in emergency situations
  - when the speed falls below 60 km/h
- hazard lights must be switched off as soon as 60 km/h is reached again
- for braking sequences with a frequency of less than 15 seconds, the vehicle's flashing lights may remain switched on for the entire test cycle
- all braking/deceleration tests need to be carried out in strict accordance with the regulation on the following pages

**1) Hard Braking Test:** longitudinal deceleration ( $a_x$ )  $\geq 0.5$  g

**Note:** only experienced drivers can be authorized by the Customer to perform this test.

Initial speed: **260 km/h – 60 km/h;**

Final speed: any.

- ① ▪ during launch phase, use the appropriate lane according to your start speed
- ② ▪ switch on your vehicle's **blue and yellow** flashing lights **at least 8 seconds** before starting the test
- ③ ▪ carefully observe the traffic
  - before braking:
    - move to lane I: if your speed is over 220 km/h
    - use the appropriate lane according to your speed: if your speed is below 220 km/h
  - during braking: gradually move from lane I to lane III according to your speed
  - also switch on your **hazard lights** if your end speed will be below **60 km/h** (compatible with your braking manoeuvre)
  - complete your braking in the appropriate lane according to your end speed
  - you must take off immediately if your end speed is below 60 km/h

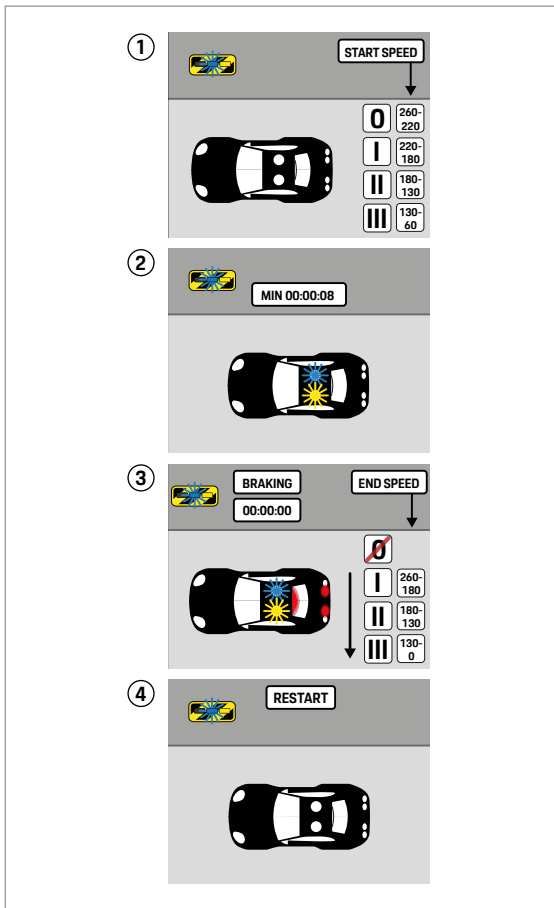

## Hard Braking Test

- ④ ▪ switch off your vehicle's flashing lights when the manoeuvre is completed
- only for braking sequences (e. g. fading test) during acceleration and braking phases it is allowed to drive in lane I also with speeds between 220 km/h and 260 km/h

Specific regulations:

- performing Hard Braking Tests is only allowed when the **blue flashing light** on the track signal panel is activated by Track Management
- Hard Braking Tests are not allowed in lane 0
- for braking sequences with a frequency of less than 15 seconds, the vehicle's blue and yellow flashing lights may remain switched on for the entire test cycle.
- The maximum number of cars allowed on the track is 50, in absence of hard braking tests.
- In case there are up to 5 hard braking tests on the track at the same time, a maximum of No. 36 cars is allowed.

1

2

3

4

5

6

7

**2) Soft Braking Test:** longitudinal deceleration ( $a_x$ ) < 0.5 g  
Initial speed: **260 km/h – 60 km/h;**

Final speed: any.

- ⑤ ▪ during launch phase, use the appropriate lane according to your start speed
- ⑥ ▪ switch on your vehicle's **yellow** flashing light **at least 8 seconds** before starting the test
  - carefully observe the traffic
- ⑦ ▪ before braking:
  - move to lane I: if your speed is over 220 km/h
  - use the appropriate lane according to your speed: if your speed is below 220 km/h
- during braking: gradually move from lane I to lane III according to your speed, using indicator lights
- also switch on your **hazard lights** if your speed is below **60 km/h**
- complete your braking in the appropriate lane according to your end speed
- you must take off immediately if your end speed is below 60 km/h
- ⑧ ▪ switch off the vehicle's yellow flashing light when the manoeuvre is completed
  - switch off the hazard lights as soon as you reach 60 km/h again

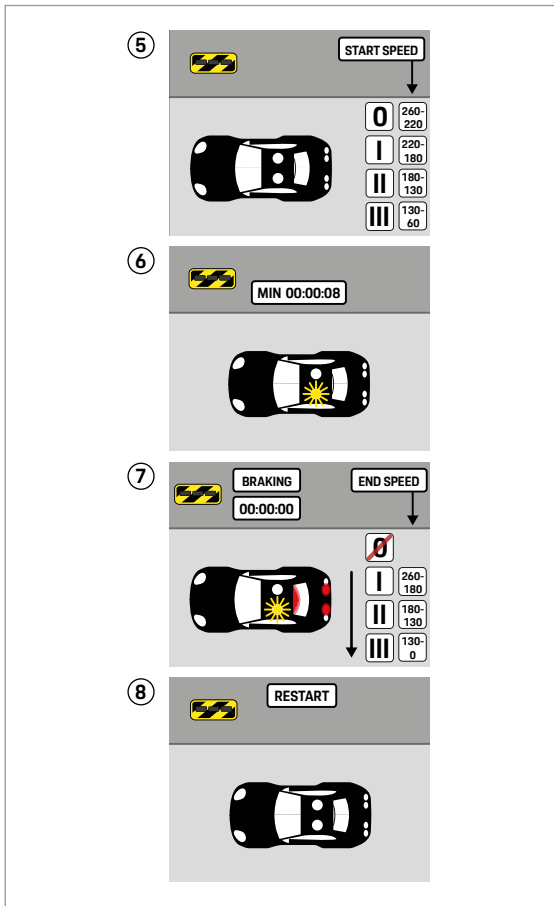

## Soft Braking Test

Specific regulations:

- Soft Braking Tests are not allowed in lane 0
- for braking sequences with a frequency of less than 15 seconds, the vehicle's **yellow flashing light** may remain switched on for the entire test cycle

### 3) Slow Down Test without Braking

- ⑨ ▪ during launch phase, use the appropriate lane according to your start speed
  - carefully observe the traffic before starting the test
  - no vehicle flashing lights have to be used for this manoeuvre
- ⑩ ▪ during deceleration (e.g. coast down), move down the lanes, respecting the appropriate lane speed ranges, using the indicator lights
- ⑪ ▪ switch on your **hazard lights** if your speed is below **60 km/h**
  - you must take off immediately if your end speed is below 60 km/h
- ⑫ ▪ switch off your hazard lights as soon as you reach 60 km/h again



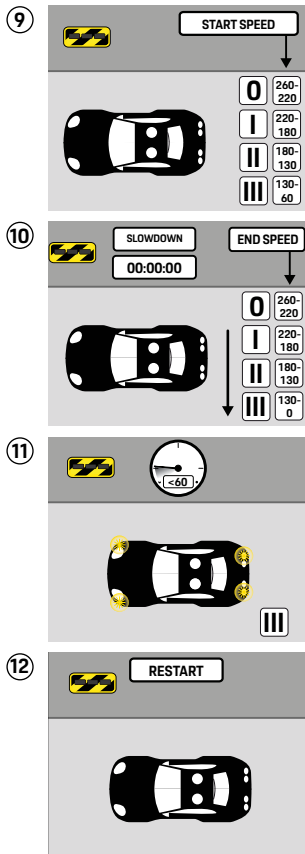

## Slow Down Test

## 7.1.2 Low Speed Ring

Low Speed Ring			
Lane	Length (m)	Compensated speed (km/h)	Allowed speed range (km/h)
X	12.516,7	136	110 – 140
XX	12.491,6	93	70 – 110
XXX	12.469,1	variable	30 – 70

Tests (and use by cars or motorcycles) need approval from Track Management.

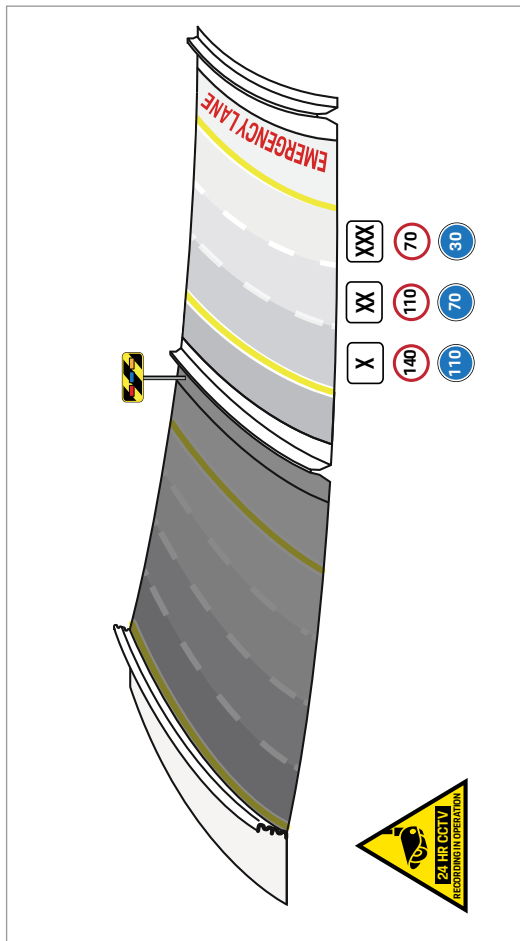

Low Speed Ring

1

2

3

4

5

6

7

## Track-specific Rules

- The speed limit is 140 km/h
- All vehicles must leave the track 10 minutes before the start of exclusive use, which is communicated 30 minutes beforehand
- You must use the appropriate lane, according to the vehicle speed
- When entering and leaving, cautiously make your way to and from this lane. Overtaking must always be performed in the outer lane
- If changing lanes, you must indicate appropriately
- Pay attention to the change in road markings.

## Safety Information

In case of an emergency:

- switch on your hazard lights and stop in the emergency lanes (preferably in the inside emergency lane)
- communicate the situation to Track Management by NTC VTS

In case of an accident, use the NTC Accident Emergency Message (see Section 6.2).

8 signal panels with red, blue and yellow flashing lights are mounted on the outer concrete wall. Emergency boxes are provided every 250 m on the same „new jersey barrier“.

1

2

3

4

5

6

7



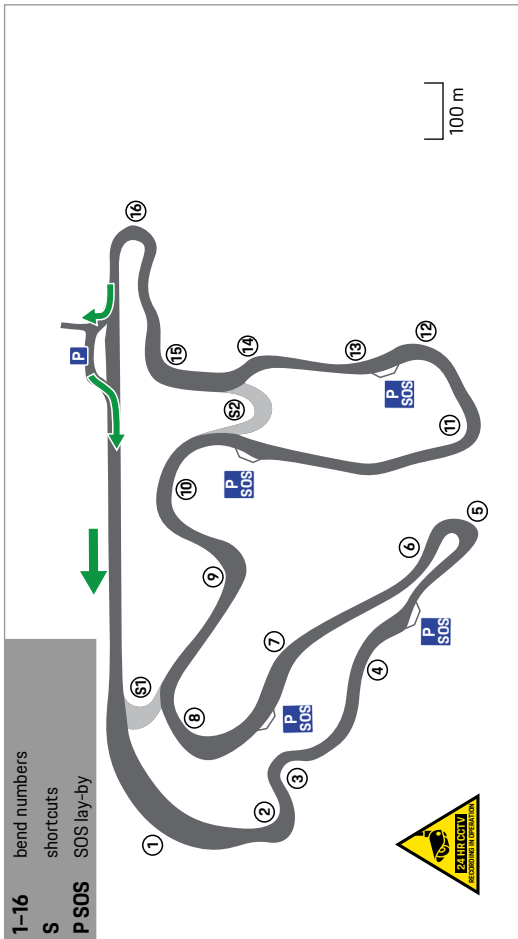

## Handling Track

1

2

3

4

5

6

7

### Track-specific Rules

This track may not be used when visibility is limited (i. e. in darkness, rain, fog, etc.). Exceptions can be authorised by Track Management together with the team leader. In the absence of daylight, the only driving mode allowed is „**extra urban driving mode**“ with lap time > 4'30". A maximum of 15 vehicles are allowed on the track at the same time. Vehicles leaving the track must warn others by using their indicators. When first using this track, an appropriate introduction by Track Management or experienced team leader is required. All vehicles must leave the track 10 minutes before the start of exclusive use, which is communicated 30 minutes beforehand.

### Safety Information

50 emergency boxes with fire extinguishers are located all around the track. Drivers forced to stop on the track should do so in an SOS lay-by or at a visible point of safety and report their position to Track Management immediately. Keep your windows closed during testing.



## Motorcycle Overtaking

- The slower motorcycle remains on the ideal trajectory
- The faster motorcycle must overtake the preceding motorcycle using the side which allows the manoeuvre to be safely performed, keeping an adequate lateral distance between them

## Car Overtaking

- The faster vehicle signals its intention to overtake by flashing its headlights
- The slower vehicle uses its indicators to show its intended movement, and reduces speed
- The faster vehicle must not overtake until the slower vehicle has indicated

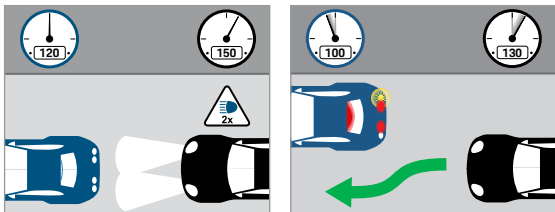

### 7.3 Track 3: Dynamic Platform A

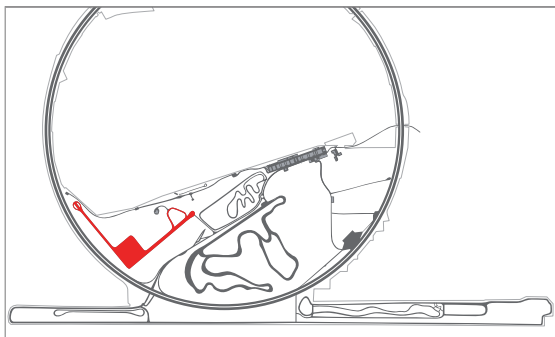

#### Dynamic Platform A

Acceleration/deceleration lanes	Length: 700 m Width: 20 m
Platform	280 x 280 m

At the end of the second straight lane, you will find a Low Friction Area (see Section 7.5) and Water Wade (see Section 7.19).

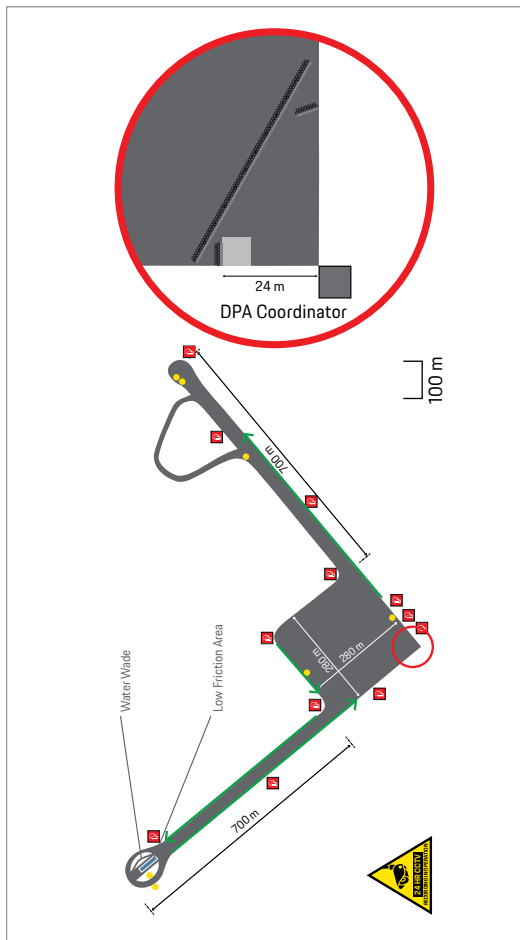

## Dynamic Platform A

1

2

3

4

5

6

7

## Track-specific Rules

**Ordinary maneuvers** shall be performed after assessing the traffic situation and verifying that the test area is clear for maneuvering.

**Extraordinary maneuvers** may only be performed in the presence of a Coordinator who must be requested and approved by the Track Management.

If the **Coordinator** is present on Dynamic Platform A (indicated on the display located at the entrance to the track and also by a lit green light placed on the Coordinator Workstation), you must contact him/her directly to coordinate your activity, which will take place through communications on a dedicated channel.

The Track Management adapts the need and the method of coordination according to the traffic.

**HB/SB tests** must be signaled with the appropriate flashing lights. Coordination of Track activities must be requested to the Track Management Office.

Cones for your manoeuvres are available in the storage container, or from the Track Management Office. After your tests, please remove the cones and put them back in the container, or bring them to the Track Management Office.

All vehicles must leave the track 10 minutes before the start of exclusive use, which is communicated 30 minutes beforehand.

## Safety Information

12 emergency boxes with fire extinguishers are located around the platform. Keep your windows closed during testing.

**Attention:** It is strictly prohibited to stop for more than 10 seconds outside the marked parking areas (indicated in yellow).

Transit from a straight to the other straight can take place according to the trajectory indicated in green and in any case always keeping to the right of the tire barrier.

1

2

3

4

5

6

7

## 7.4 Track 4: Dynamic Platform B

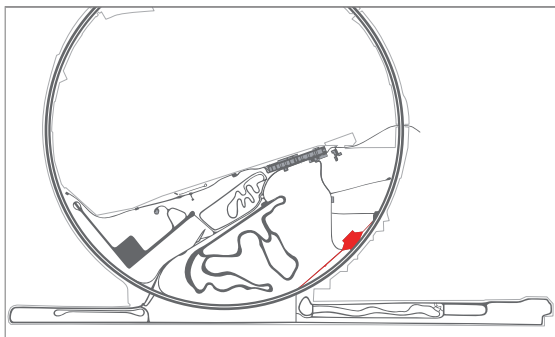

### Dynamic Platform B

Platform

175 x 150 m

#### Track-specific Rules

Before starting your test programme, you must contact Track Management to find out about any planned activities on the platform and to define the necessary testing area. At the beginning of your test, approach the platform slowly and observe the traffic situation. Be extremely careful and make sure that your assigned space is actually free for your manoeuvres. All vehicles must leave the track 10 minutes before the start of exclusive use, which is communicated 30 minutes beforehand.

## Safety Information

Four emergency boxes with fire extinguishers are located around the platform. Keep your windows closed during testing.

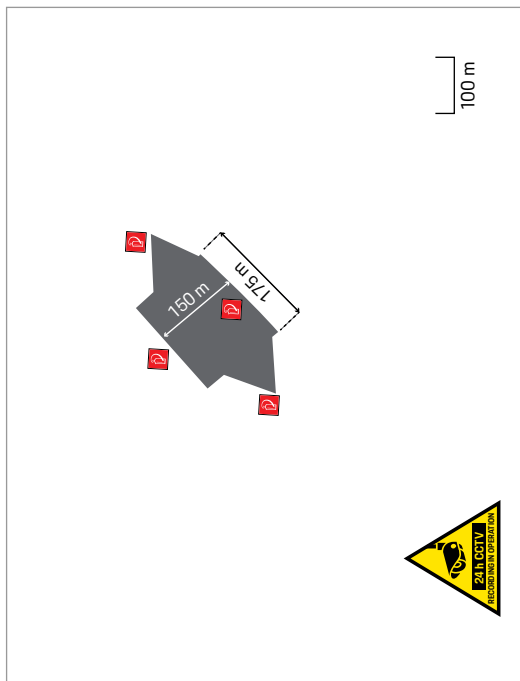

Dynamic Platform B

1

2

3

4

5

6

7

## 7.5 Track 5: Low Friction Area

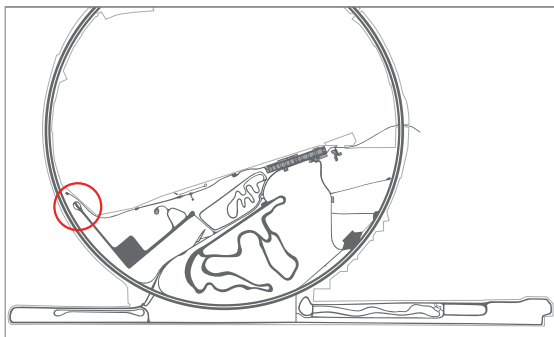

### Low Friction Area

Length	50 m
Width	4 m
Surface	Ceramic tiles
Adjacent surface	AC 12
Friction coefficient:	0,1

This track is located at the end of the second straight lane of the Dynamic Platform A. It is a flat surface with ceramic tiles and a series of water spray nozzles to keep the surface wet. It can be used for acceleration and braking at low speed in slippery conditions. At the test area is located an emergency box with fire extinguisher.



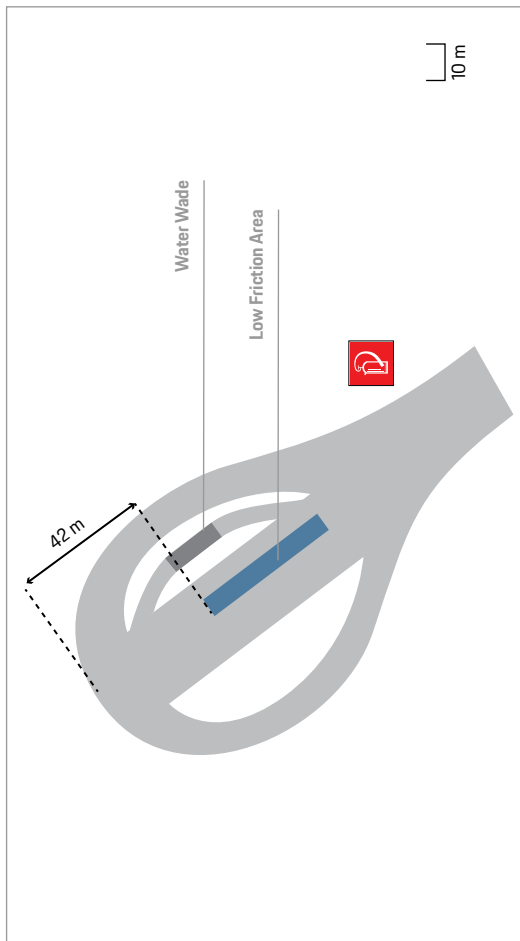

Low Friction Area

1

2

3

4

5

6

7

### **Track-specific Rules**

This area may not be used in dry conditions. Before starting and after finishing your tests, please inform Track Management so they can switch the watering system on and off. During your tests, you can clean the tiles using the equipment from the box next to the track. In case you need help, please contact Track Management.

Please be extremely careful walking over the wet tiles, as they are slippery.

1

2

3

4

5

6

7

## 7.6 Track 6: Noise Track

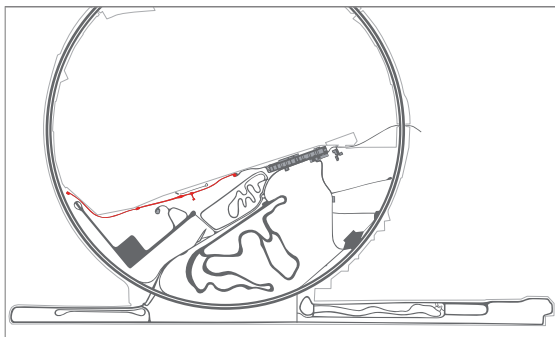

### Noise Track

Length	2.132 m
Width	4 m

The surface of the first area is certified in accordance with ISO 10844. This track is only available for exclusive use. Track Management can provide measuring equipment.

All vehicles must leave the track 10 minutes before the start of exclusive use, which is communicated 30 minutes beforehand.

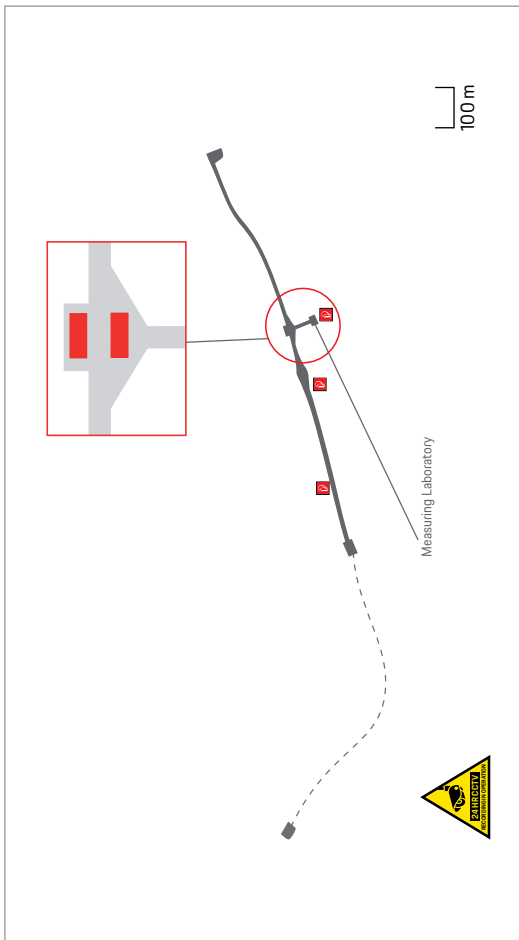

Noise Track

2

3

4

5

6

7

Noise Track

## **Safety Information**

Three emergency boxes with fire extinguishers are located along the track.

## **Track-specific Rules**

### **Dynamic Testing**

On the test area, it is only permitted to proceed at a constant speed or to perform pass-by maneuvers as specified in the already known regulations.

Stopping and/or reversing is not allowed on the test area.

### **Stationary Tests**

Stopping along the driving lanes is not allowed: you may stop only in the areas shown on the inset and only to conduct stationary noise tests.

1

2

3

4

5

6

7

## 7.7 Track 7: Special Pavements Track

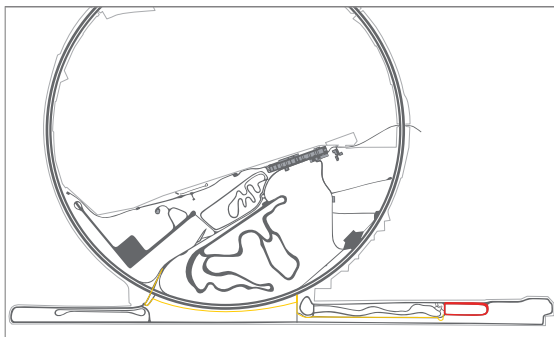

### Special Pavements Track

Length	1,150 m
Width	8 m
Surface	Cobblestones, Pot-Holes, Twist, Washboard Road, Heavy Pavé, Long Waves, Rails

### Track-Specific Rules

On this track, only clockwise driving is allowed.

All vehicles must leave the track 10 minutes before the start of exclusive use, which is communicated 30 minutes beforehand.



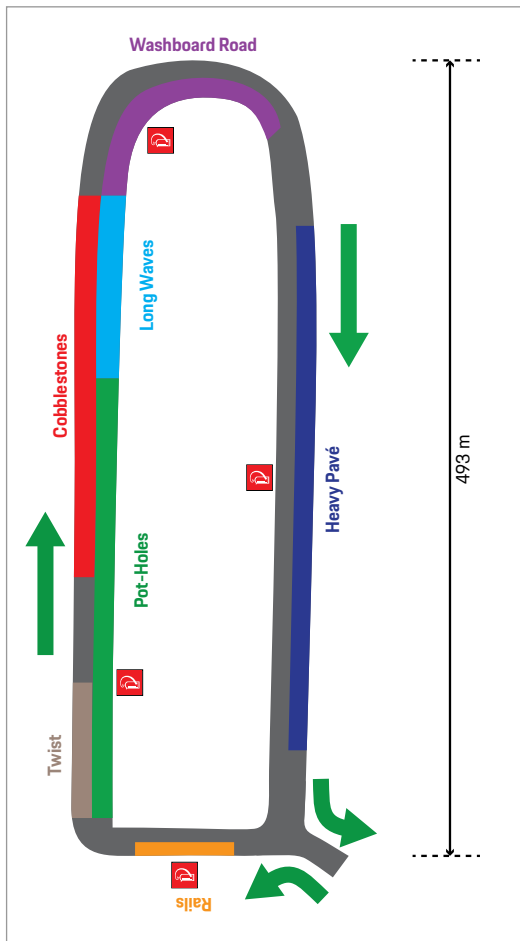

## Safety Information

Along the track there are 4 emergency pillars equipped with fire extinguishers. If you wish to access the track via the Patrol Lane of the High Speed Ring (as shown in yellow in the image below), we recommend that you use extreme caution and adhere to the posted speed limits.

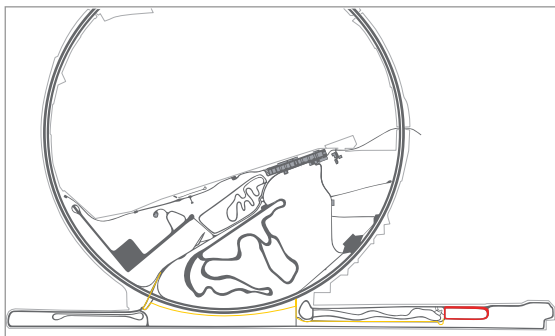

1

2

3

4

5

6

7

## 7.8 Track 8: Strada Bianca Off-Road

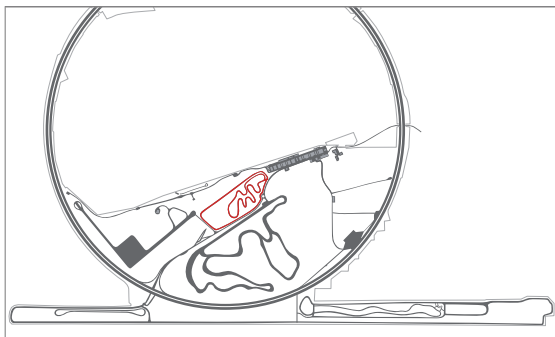

Strada Bianca Off-Road 'O'	Strada Bianca Off-Road 'S'
Length: 2,130 m	Length: 2,135 m
Width: 6 m	Width: 6 m
Surface: Dust	Surface: Dust

There are two track routes on this track, 'O' and 'S', with the same surface.

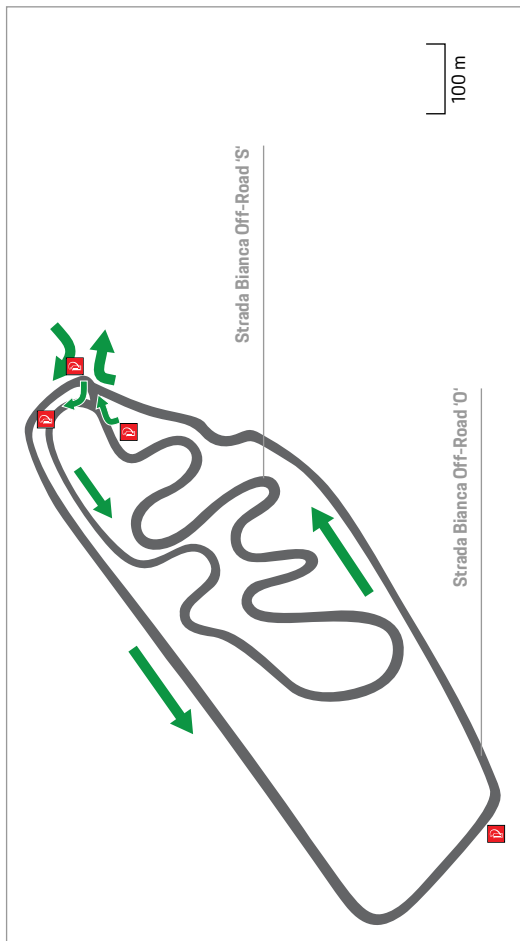

Strada Bianca Off-Road 'S' and 'O'

1

2

3

4

5

6

7

### **Track-specific Rules**

On this track, only anti-clockwise driving is allowed.

Before starting the test session, inform the Track Management Offices.

All vehicles must leave the track 10 minutes before the start of exclusive use, which is communicated 30 minutes beforehand.

### **Safety Information**

Four emergency boxes with fire extinguishers are located along the track. Please be careful on this track, especially in the bends, because of the low friction surface.

1

2

3

4

5

6

7

## 7.9 Track 9: Dust & Gravel Oval

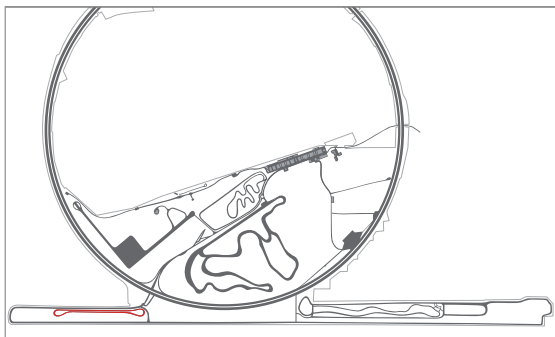

### Dust & Gravel Oval

Length	2,150 m
Width	10 m
Surface	Dust, gravel

#### Track-specific Rules

On this track, only anti-clockwise driving is allowed. All vehicles must leave the track 10 minutes before the start of exclusive use, which is communicated 30 minutes beforehand.

#### Safety Information

Three emergency boxes with fire extinguishers are located along the track. Before starting the test session, inform the Track Management Offices.



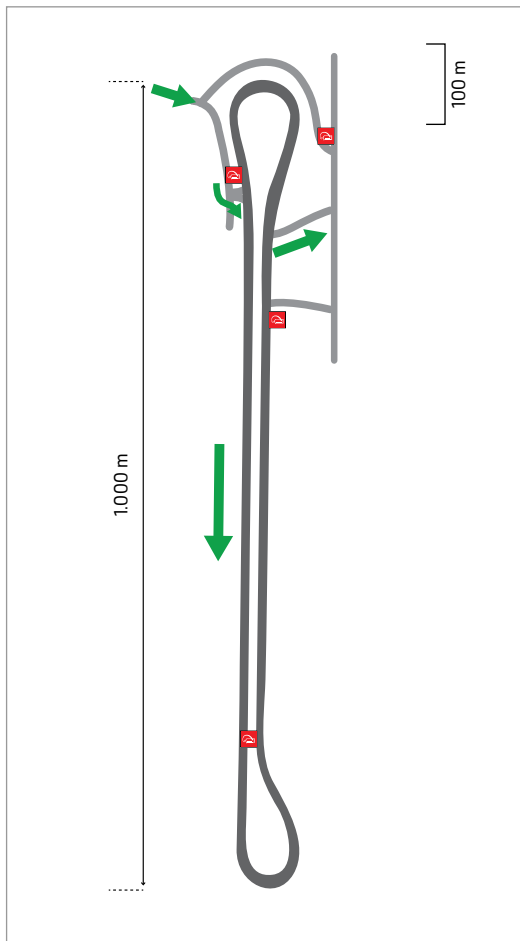

## Dust & Gravel Oval

1

2

3

4

5

6

7

## 7.10 Track 10: Africa Road

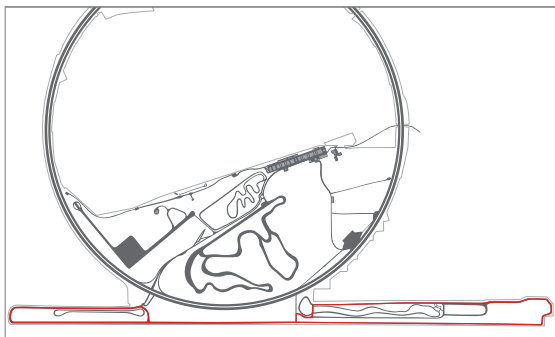

### Africa Road A-B-C

Length	10,500 m
Width	4 m
Surface	dirt, dust, stones, rock

### Track-specific Rules

Before starting your test programme, you must contact Track Management to find out about any planned activities on the road. On the track, only anti-clockwise driving is allowed.

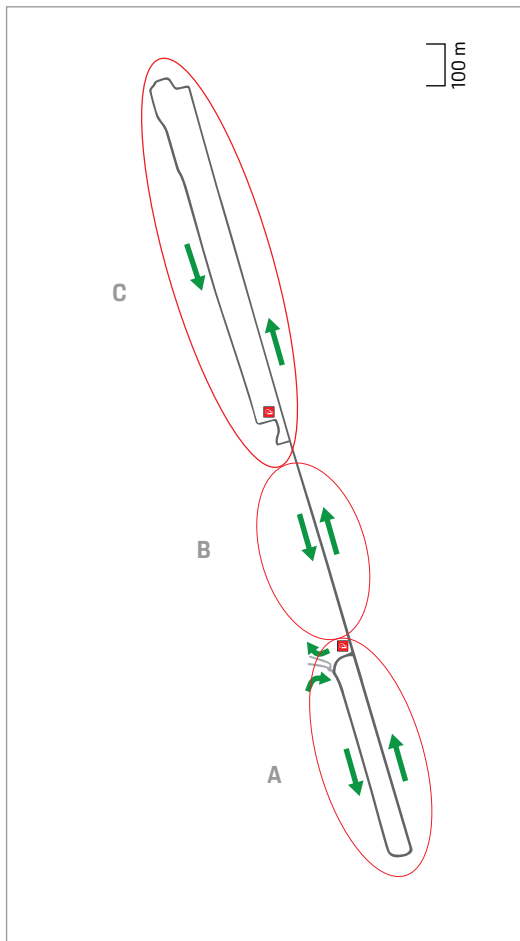

**Attention:** along a short section of this track, driving in both directions is allowed. Respect the signs that indicate the driving direction.

All vehicles must leave the track 10 minutes before the start of exclusive use, which is communicated 30 minutes beforehand.

### **Safety Information**

Two emergency boxes with fire extinguishers are located along the track.

1

2

3

4

5

6

7

## 7.11 Track 11: Tire Laceration Road

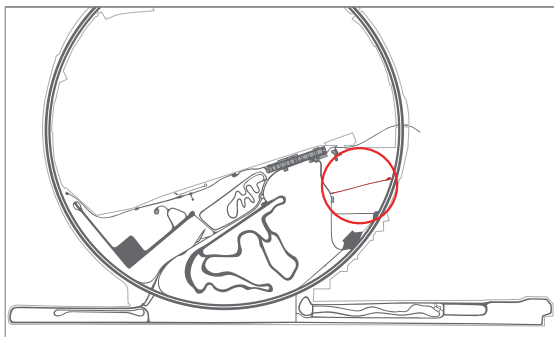

### Tire Laceration Road

Length	650 m
Width	4 m
Surface	Stones (size 4–7 cm)

This short track is only available in exclusive use. Before starting the test session, inform the Track Management Offices.

All vehicles must leave the track 10 minutes before the start of exclusive use, which is communicated 30 minutes beforehand.

### Safety Information

Two emergency boxes with fire extinguishers are located along the track.

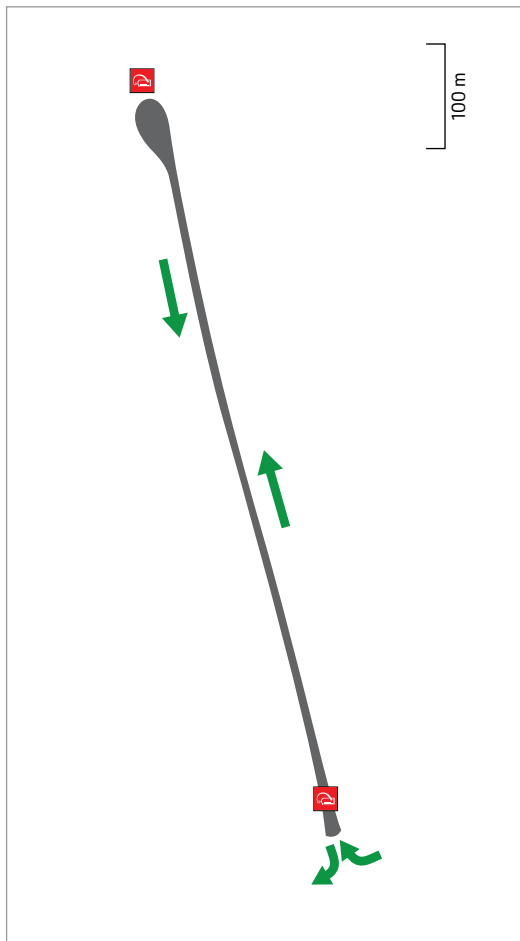

## Tire Laceration Road

1

2

3

4

5

6

7

## 7.12 Track 12: Cross-Country Road

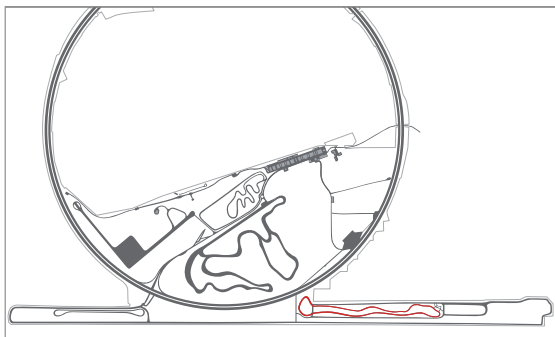

### Cross-Country Road

Length	3,500 m
Width	4 m
Surface	Compact soil, dust, stones, rock

This track is also a dedicated area with several Off-Road Slopes.



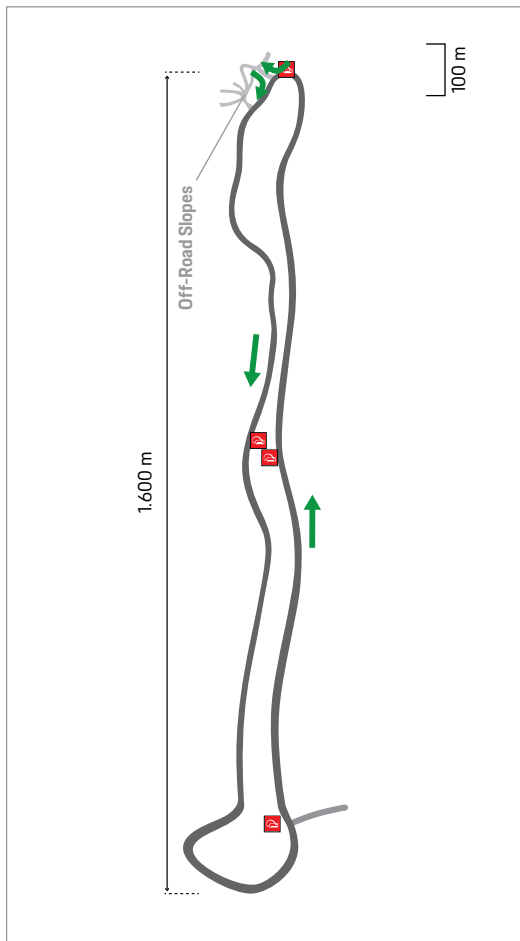

## Cross-Country Road

1

2

3

4

5

6

7

### **Track-specific Rules**

On this track, only anti-clockwise driving is allowed.

Before starting the test session, inform the Track Management Offices.

All vehicles must leave the track 10 minutes before the start of exclusive use, which is communicated 30 minutes beforehand.

### **Safety Information**

Four emergency boxes with fire extinguishers are located along the track.

1

2

3

4

5

6

7

## 7.13 Track 13: Mud Road (with Water Wade)

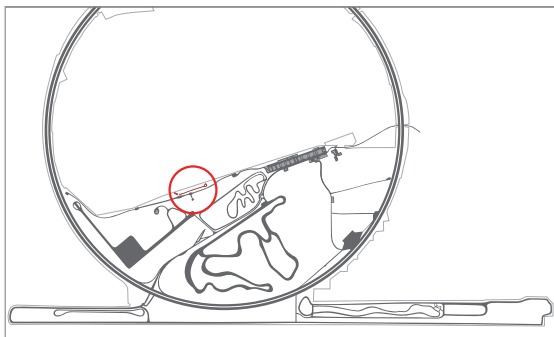

Mud Road		Water Wade	
Length:	450 m	Length:	18 m
Width:	4.5 m	Width:	4.05 m
Surface:	Mud	Depth:	1,6 m
		Ramp gradient:	16%

This track has a watering system that produces a muddy surface over 300 m. A deep Water Wade (see Section 7.19) for heavy vehicles is located close to this road.

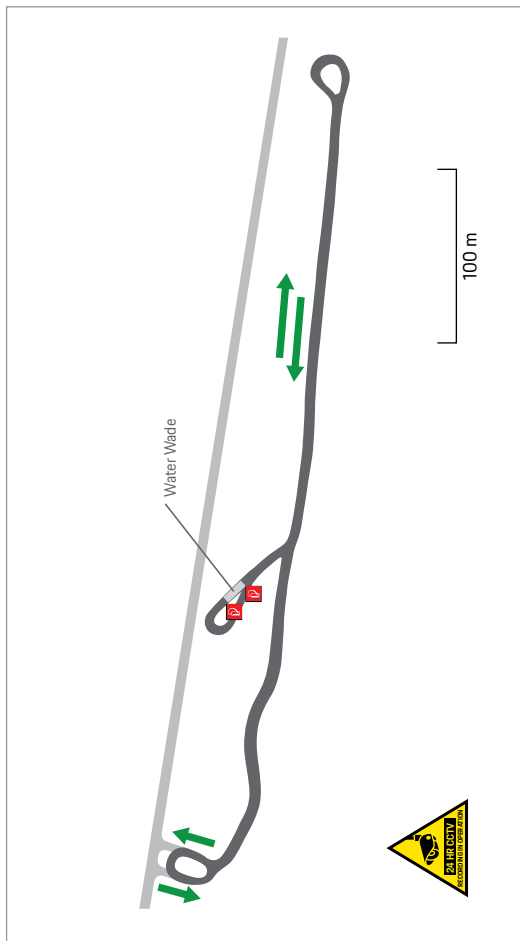

## Mud Road

1

2

3

4

5

6

7

### **Track-specific Rules**

Please inform Track Management before performing your testing activity. The watering system can only be switched on by Track Management personnel. Be sure to clean your tires in the Water Wade before returning to regular roads.

All vehicles must leave the track 10 minutes before the start of exclusive use, which is communicated 30 minutes beforehand.

### **Safety Information**

Two emergency boxes with fire extinguishers are located along the track.

1

2

3

4

5

6

7

## 7.14 Track 14: Concrete Slopes

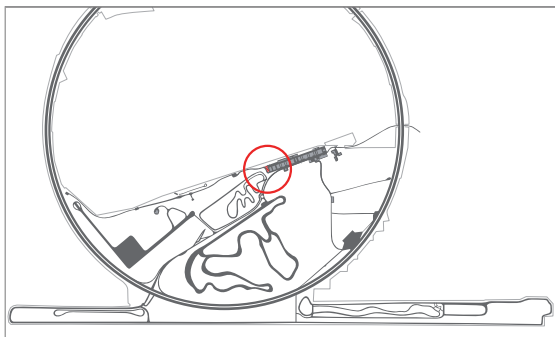

### Concrete Slopes

Length	10 m
Width	4 m
Surface	Concrete
Gradients	6%, 12%, 18%, 30%



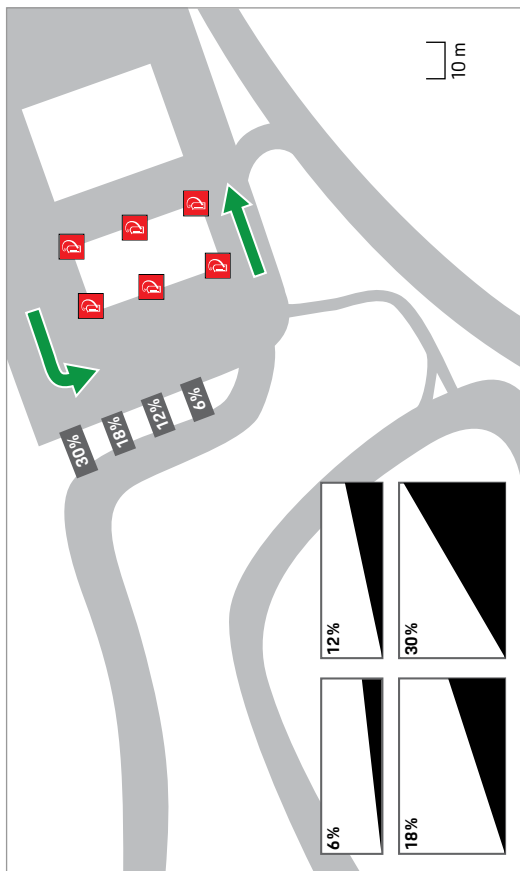

## Concrete Slopes

1

2

3

4

5

6

7

### **Track-specific Rules**

Please inform Track Management before starting and after finishing your tests.

All vehicles must leave the track 10 minutes before the start of exclusive use, which is communicated 30 minutes beforehand.

### **Safety Information**

Six emergency boxes with fire extinguishers are located next to the slopes.

Please pay attention to the traffic around the track.

1

2

3

4

5

6

7

## 7.15 Track 15: Rolling Track

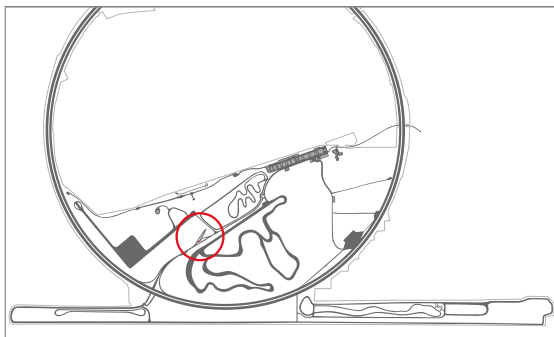

### Rolling Track

Length	5 m
Width	2,25 m
Roller rows	2
Material	Steel

Before starting and after finishing your tests, please inform Track Management.

All vehicles must leave the track 10 minutes before the start of exclusive use, which is communicated 30 minutes beforehand.

### Safety Information

Emergency boxes with fire extinguishers are located nearby.

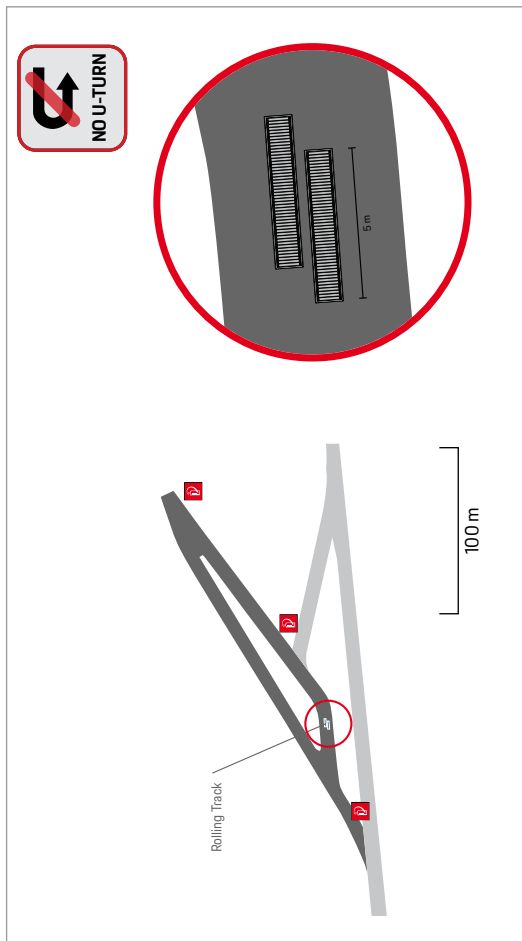

## Rolling Track

1

2

3

4

5

6

7

## 7.16 Track 16: Reverse Gear Track

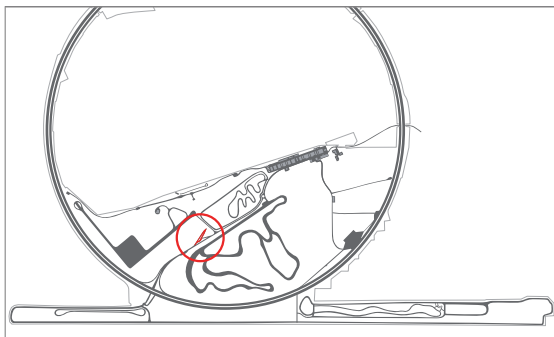

### Reverse Gear Track

Test Lane Length	150 m
Exit Lane Length	240 m
Width	6 m

You have to inform Track Management about the start and end of your test session. The Rolling Track is located on the Reverse Gear Track, outside the testing area (see Section 7.15).

All vehicles must leave the track 10 minutes before the start of exclusive use, which is communicated 30 minutes beforehand.

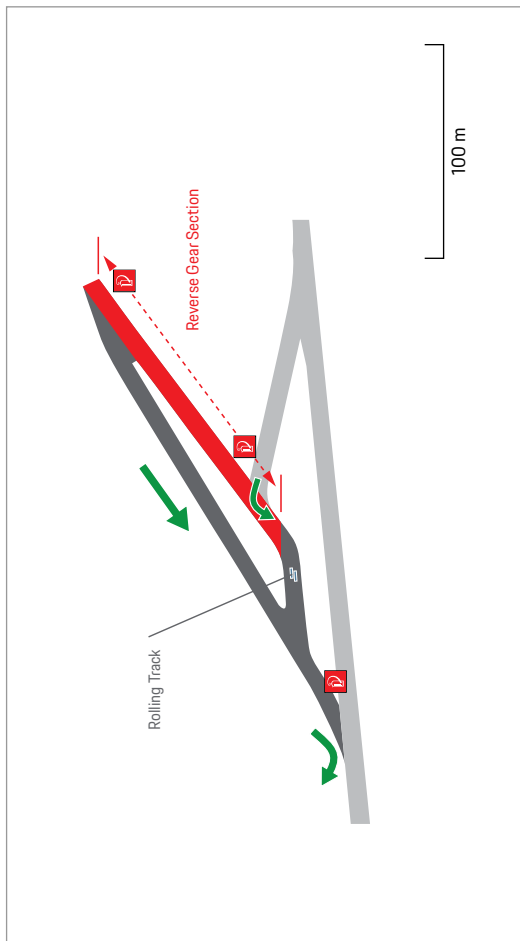

## Reverse Gear Track

1

2

3

4

5

6

7

## 7.17 Vapour Locks

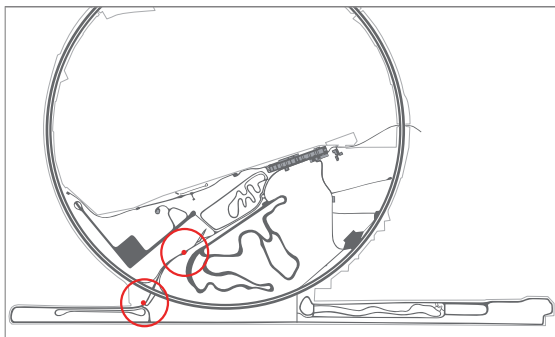

Located as indicated on the map, several Vapour Locks are available for your testing. Moveable Vapour Locks can also be provided on demand.

### Vapour Lock Rules

Before starting your tests, you have to inform Track Management.

### Safety Information

In case of fire, a fire extinguisher is located near each Vapour Lock.



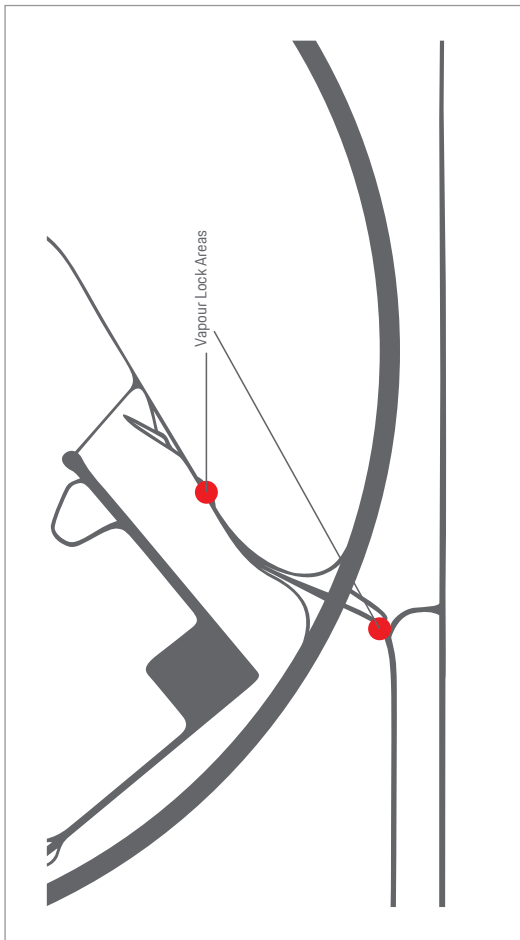

## Vapour Locks Location

1

2

3

4

5

6

7

## 7.18 Water Wades

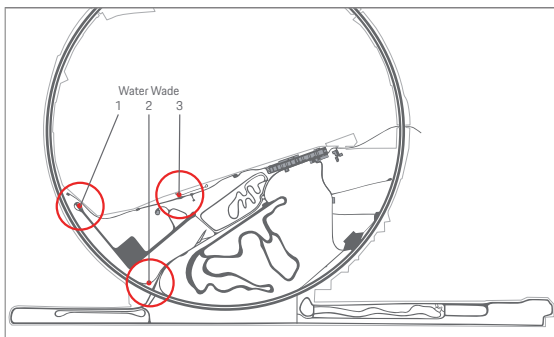

There are three different Water Wades available for various kinds of test activities.

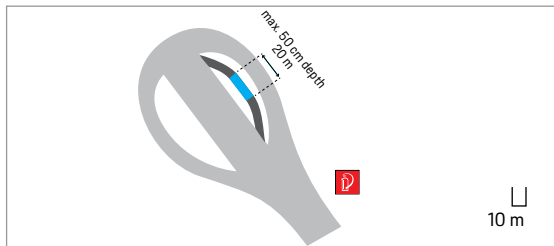

Water Wade 1

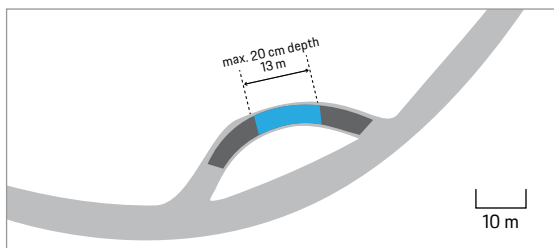

Water Wade 2

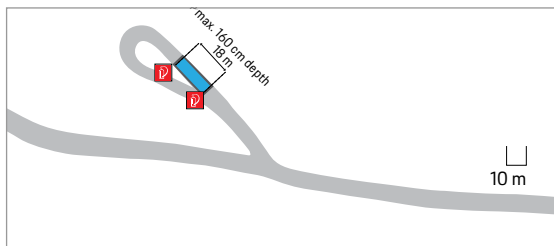

Water Wade 3

1

2

3

4

5

6

7

## 7.19 Pergola Water Spray

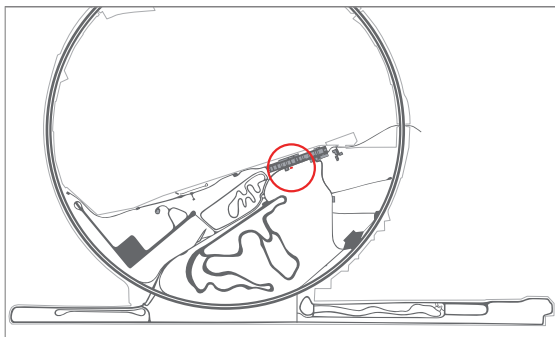

Please contact Track Management before starting your tests.

### Safety Information

An emergency box with fire extinguisher is located nearby.

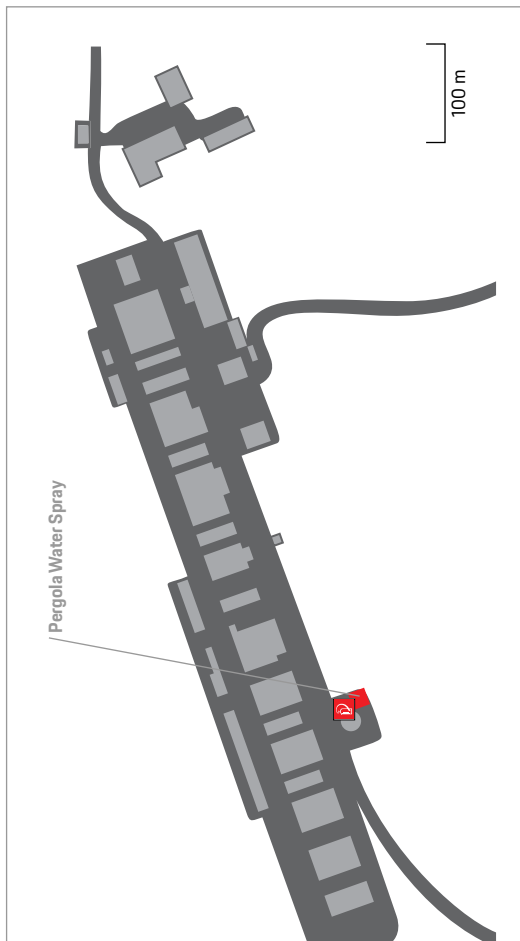

Pergola Water Spray Location

1

2

3

4

5

6

7

## 7.20 Curbstone Area

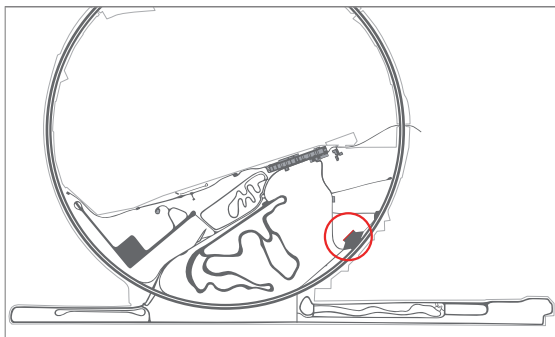

This area (100 m long and 0.15 m high) is located on the Dynamic Platform B.

### Safety Information

An emergency box with fire extinguisher is located nearby.

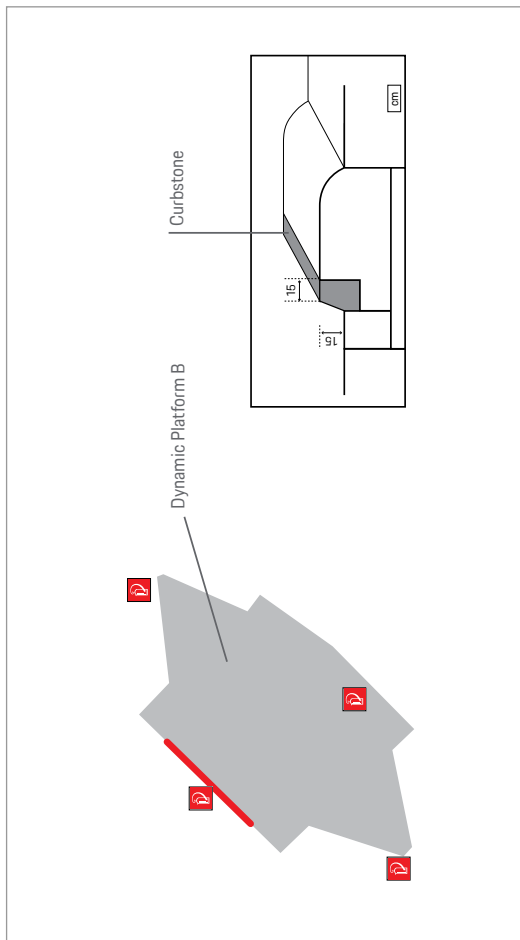

Curbstone Area

1

2

3

4

5

6

7

## 7.21 Assisted Parking Test Area

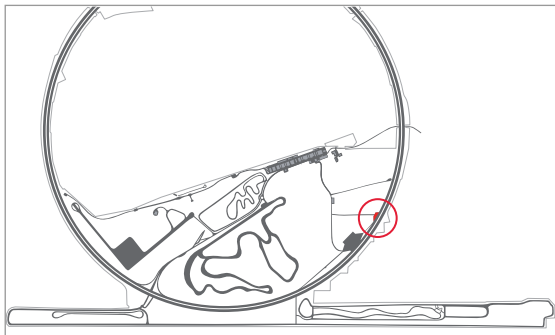

This area is 130 meters long and 35 meters wide and is accessible from the Low Speed Ring.

### Track-specific Rules

The test area cannot be used for stopping/parking. Contact the Track Management before starting the test session.

### Safety Information

Fire extinguisher-equipped emergency pillars are present along the «New Jersey» track. The box contains a fire extinguisher and a first aid kit.

In case of evacuation, go to the meeting point indicated on the map and wait for instructions from the NTC emergency team.



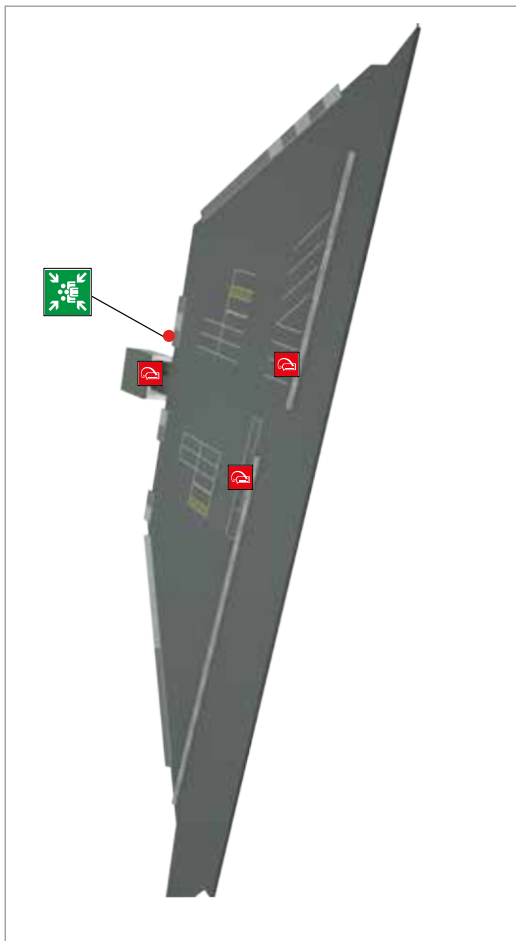

## Assisted Parking Test Area

1

2

3

4

5

6

7

## 8. Facilities and Services upon Request

### 8.1 Services upon Request

The following services can be requested from Track Management Office:

- storage/handling of special fuels
- cooling of special fuels
- use of scales
- 20 kg ballast bags
- ballast dummies (water filling)

### 8.2 Workshops

The following equipment is available in the workshops:

- hoists
- air conditioning systems
- compressed air system
- water supply
- workbenches
- exhaust gas extractors
- first aid kit
- fire extinguishers
- fire and evacuation emergency kit
- environmental management and emergencies kit

## General Information and Recommendations

- in the event of an emergency, follow the evacuation plan
- pay the utmost attention to personal safety during the operational phases
- always make sure that there are at least two people in the work area
- leave the area around the fire extinguishers, hydrants, and electrical panels clear and accessible
- cooking is not allowed in the workshop except in the equipped areas
- smoking is not allowed in enclosed areas
- do not remove or modify any safety devices from the equipment
- keep tools, equipment, and the work area clean at all times
- do not modify or alter the tools/equipment
- inform NTC Customer Service of any failure or malfunction of the equipment/tool
- before starting work, wear the appropriate protective equipment identified and required by your company
- hot work (welding) and the use of naked flames are not allowed
- obey all safety notices in the workplace



- read/follow the user manual of each equipment
- it is strictly forbidden to charge electric cars by plugging them into the sockets inside or outside the workshops (use the appropriate charging station for electric/hybrid cars)
- it is allowed to start the engine of the vehicle in the workshops equipped with an exhaust system, for the time necessary for the checks
- any hazardous materials must be handled after wearing appropriate protective clothing
- the amount of oil and flammable materials in the tire shop should not exceed the amount needed for daily use
- sort the waste using the appropriate containers
- it is forbidden to make system and structural changes of any kind
- comply with the storage instructions provided in each room
- in the event of a spill, use the kit provided and contact Customer Service immediately
- for hygienic and safety reasons it is forbidden to feed cats or other animals
- clear emergency exits and escape routes

### Instructions for hoists

- follow the instructions near the control panel
- do not exceed the maximum load indicated on the hoist

### At the end of daily activities at NTC, and before leaving the workshop:

- turn off the lights
- turn off the air conditioning
- close all doors and windows
- gather your belongings
- return the access key to the Security Reception and contact the Security staff to inform them of normal and daily activities and materials that need to be stored or rendered unusable

### At the end of the test session at NTC, and before leaving the workshop:

- turn off the lights
- turn off the air conditioning
- close all doors and windows
- gather your belongings
- return the access key to the Security Reception and complete the reports required to manage the client's material

# PORSCHE

Porsche, the Porsche Crest and other marks are registered trademarks of Dr. Ing. h.c. F. Porsche AG.

All text, images and other information in this publication are subject to the copyright of Dr. Ing. h.c. F. Porsche AG.

No part of this publication may be reproduced or transmitted, in any form or by any means, without the prior written consent of Dr. Ing. h.c. F. Porsche AG.

Edition: 01/2024